

Behavior of Masonry Loadbearing Walls

F. ABOUL-ELLA

*Department of Building Science and Technology,
College of Architecture & Planning,
King Faisal University, Dammam, Saudi Arabia*

ABSTRACT. Loadbearing masonry walls are slender compression elements subjected to in and out-of-plane bending. The static behaviour of such elements is studied and a computer program (DESW) for their analysis and design is developed so that it is possible to perform parametric study on wall systems. The parametric study can include the effect of wall dimensions, slab type, percentage of solid area, mortar bedded area, area of grout, type of masonry (brick or block), and the percentage of vertical reinforcement. It is concluded that the hollow wall section, in which grouted cells and steel bars are placed one meter apart with face shell mortar bedding, is the most proper system for low and medium-rise masonry buildings in the Kingdom of Saudi Arabia.

1. Introduction

Although the infilled reinforced concrete frame structures are expensive and have shown problems of cracking and spalling of the plastering, they are dominant in both low and medium rise buildings in the Kingdom of Saudi Arabia. This system uses extensive form work, it doesn't utilize the bearing capacity of the walls, and its shallow supporting beams require high steel percentages. From the structural, constructional, and energy points of view, loadbearing masonry buildings rank superior to the frame buildings^[1]. The walls act as partitions and load carrying structural elements with excellent thermal and acoustical insulation properties. Exterior surfaces are finished surfaces while the interior ones can be painted directly or treated in a number of ways. The hollow nature of walls allows for vertical communication of utilities and reinforcement. All form works are eliminated by using precast slab sys-

tems bearing on the masonry walls^[2,3]. Reinforced walls can serve effectively as shear walls in resisting bending and shear forces due to lateral loads^[4,5], because the reinforcement increases the ductility of these walls.

A research project^[6] has been conducted at the College of Architecture, King Faisal University, aiming to introduce the masonry systems to the Saudi Construction Industry. In this project the Canadian code for masonry design^[7], which is more modern than the American code^[8], was considered to be the starting code for the design and new development of masonry systems in Saudi Arabia. This is because of the significant amount of masonry research that has been conducted in North America. Both Canadian and American codes are based on the working stress design method which is simple and has proved its adequacy in providing conservative design with satisfactory performance. It is hoped that through more experimental research work and experience in practical applications using local materials and construction techniques, adequate data base will be available which will allow the evaluation of design parameters and help develop the Kingdom's own code.

This paper deals with the analysis, design, and behavior of loadbearing masonry walls and presents design aids for these walls in the form of a computer program. The program can analyze up to five load combinations and returns the required masonry compressive strength f'_m for design. The wall section could be solid, hollow, partially or fully grouted, reinforced or unreinforced, and the mortar bedding can cover only the face shell or the whole section.

The behaviour of selected walls of two and ten storey buildings, using different wall sections, has been studied and presented; from which general conclusions have been drawn.

2. Analysis

Bearing wall masonry buildings are rectangular box-like arrangements (Fig. 1-a) of block or brick masonry that effectively carry the induced dead and live loads to the foundations without the help of columns or frames. In such structures, lateral loads due to wind or earthquakes are resisted by the bearing walls acting as shear walls connected by rigid reinforced concrete floor slabs (diaphragms). The shear wall system utilizes floors as diaphragms to distribute the lateral forces to the walls according to their flexural and shear stiffnesses.

Each loadbearing wall panel (Fig. 1-b) is subjected to the following internal forces :

1. Axial load P due to dead and live loads.
2. Bending moment M_y and the corresponding shearing force V around the weak axis of inertia $y-y$. This moment and shear are due to :
 - a) Slab's dead and live loads.
 - b) Perpendicular wind pressure (for external walls).
 - c) $P - \Delta$ effect.

The moment M_y due to the slab loads depend on the type of connection between

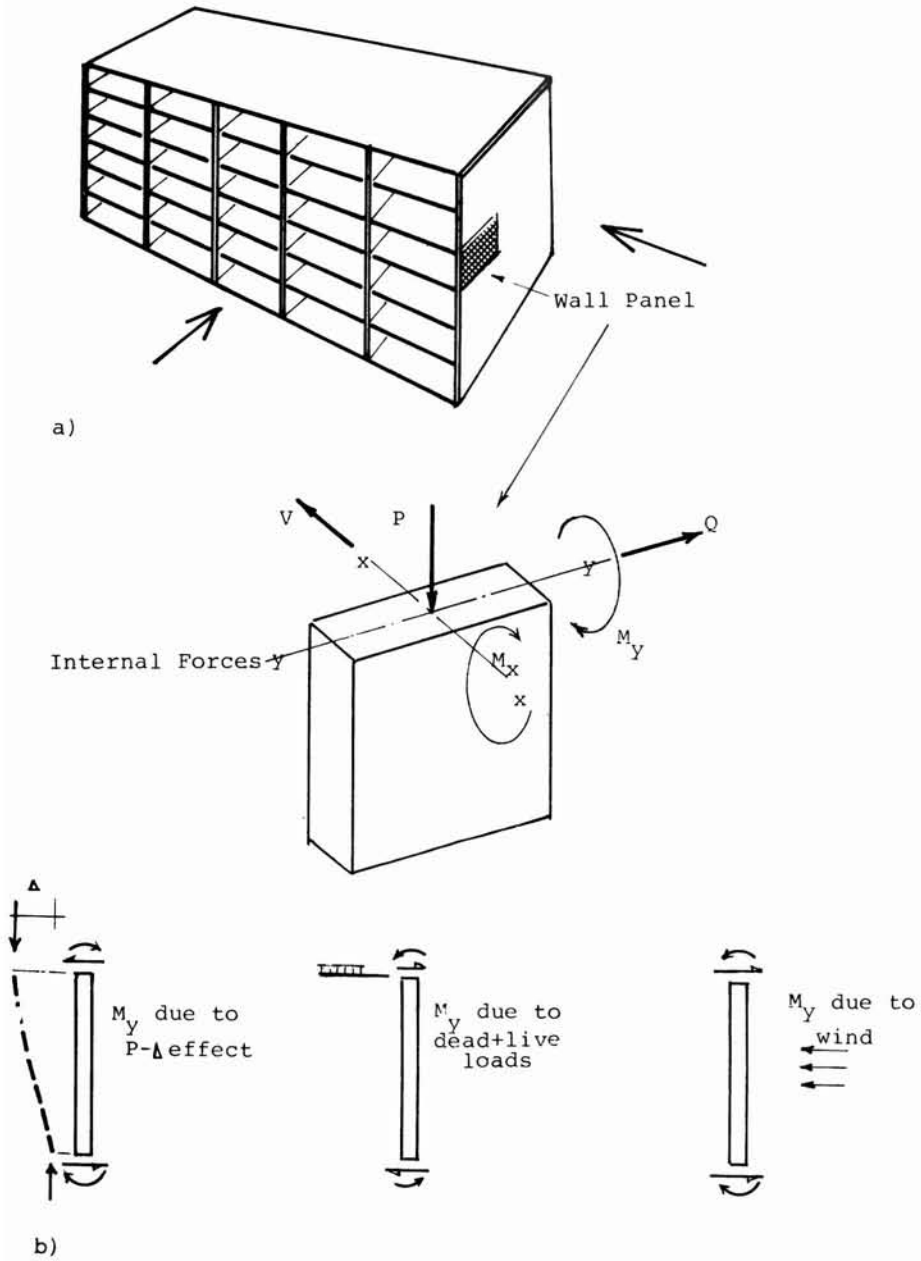
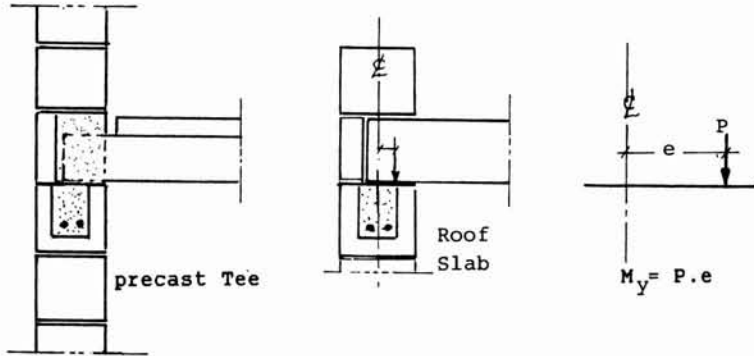
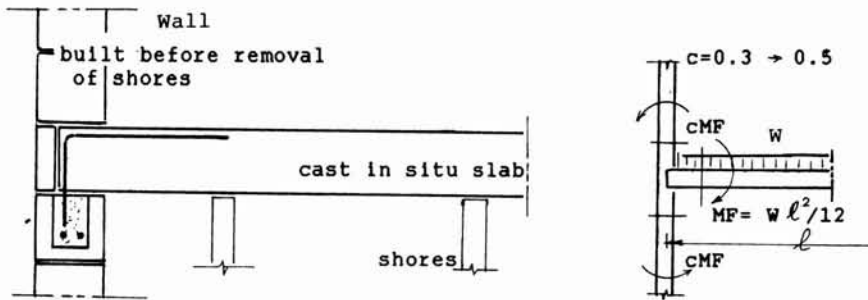

FIG. 1. Typical loadbearing wall building and panel's internal forces.

the slab and the wall as shown in Fig. 2. In a hinged condition the moment M_y is a result of the load eccentricity (Fig. 2-a) while in a fixed condition M_y can be calculated assuming rigid connections between the walls and the floors^[9] (Fig. 2-b). A simple way of doing this is to assume a floor slab moment at the face of the support equal to $W \cdot l^2/12$ and to distribute it among the walls (Fig. 2-b), where W is the load per unit length of the slab and l is its span.



a) Hinged Conditions for both M_{dl} and M_{ll} .



b) Fixed Conditions for both M_{dl} and M_{ll} .

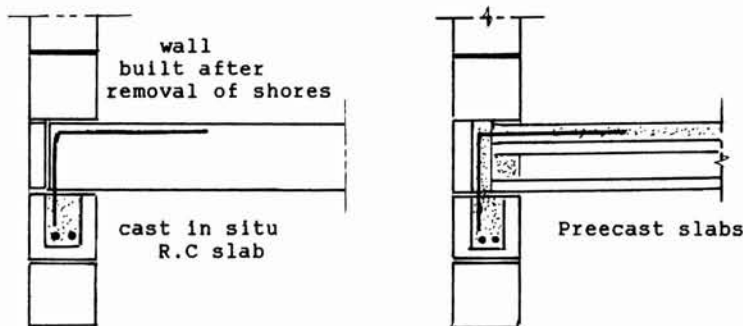

c) Hinged Condition for M_{dl} and Fixed for M_{ll} .

FIG. 2. Effect of floor-wall connections on M_y .

It is a good practice to consider the hinged condition ($M_y = P \cdot e$) for the bending moment from dead loads (M_{dl}) and fixed condition for the bending moment from live loads (M_{ll}). This is because the wall above the slab is often built after the removal of shores and also it is the common practice for precast slabs (Fig. 2-c). The precast Tee slab produces less moment (hinged condition for both dead and live load moments) but it is not practical for residential buildings. The cast in place slab with wall built before removal of shores (Fig. 2-b) produces undesirable moment (fixed condition for both dead and live load moments) and therefore it is not a recommended for practical applications.

3. Bending moment M_x and shearing force Q (Fig. 1-b) due to parallel wind loads. M_x requires three dimensional analysis of the entire structure to be accurately calculated, but a simplified analysis in which the external lateral loads are distributed among the walls according to their relative rigidities and their locations from the center of rigidities (torsional effects) can be accepted for simply arranged buildings^[6].

3. Design

Up to five cases of load combinations can be developed and, therefore, should be considered in design. These load combinations are :

1. Load P and moment M_y from dead and total live load + moment M_x from parallel wind (allowable stresses are increased by 33%).
2. P and M_y from dead loads + M_x from parallel wind.
3. P and M_y from dead and reduced live loads.
4. P and M_y from dead and total live load + M_y from perpendicular wind (allowable stresses are increased by 33%).
5. P and M_y from dead loads + M_y from perpendicular wind.

According to the coefficient method described in the Canadian code^[7], the walls allowable vertical load P can be estimated as shown in the flow chart of Fig. 3 in which:

A_m = mortar bedded area, C_e = eccentricity coefficient, C_s = slenderness coefficient, e = virtual eccentricity, f'_m = ultimate compressive strength of masonry at 28 days, F_a = the tabulated allowable axial compressive stresses in masonry, f_a = the calculated axial compressive stress, f_b = the calculated flexural compressive stress, F_b = the tabulated allowable flexural compressive stress normal to the bed joint, F_t = the tabulated allowable flexural tensile stress normal to the bed joint (Table 1), and P = allowable vertical load.

The slenderness and eccentricity coefficients are given in reference [7] and presented here in Fig. 4-a in which :

h = effective height of wall, t = effective thickness of wall, e_1 = the smaller virtual eccentricity occurring at the top or bottom of a vertical member at lateral supports; and e_2 = the larger virtual eccentricity occurring at the top or bottom of a vertical

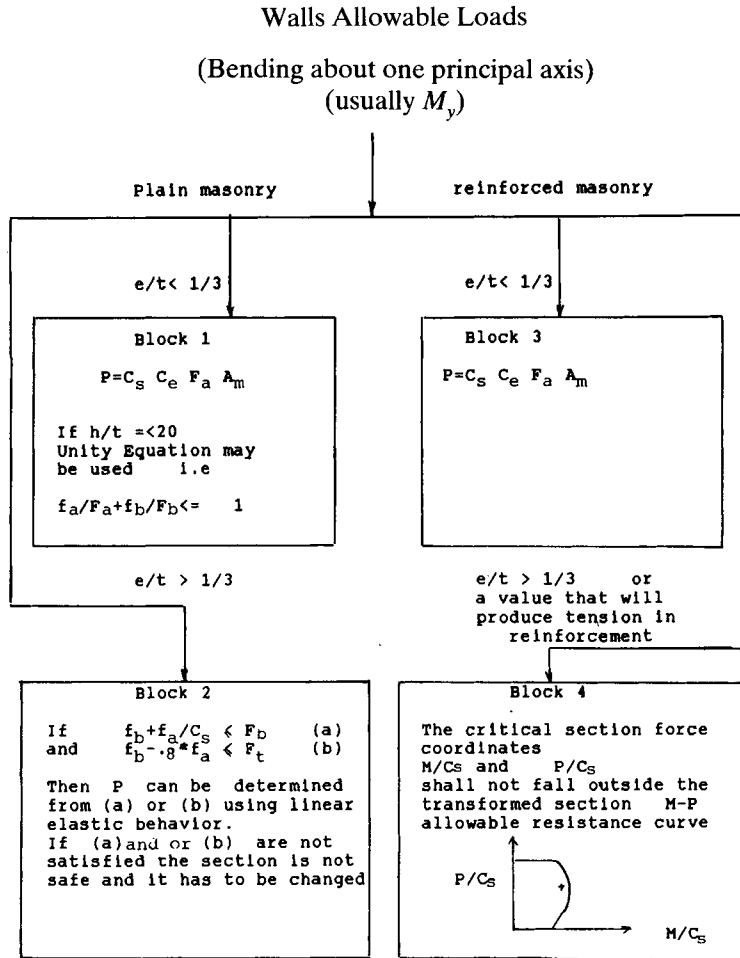

FIG. 3. Flow chart for allowable loads of walls.

TABLE 1. Allowable stresses for walls^[7].

Type of masonry	Axial comp. F_a	Flexural comp. F_b	Flexural ten. F_t (kPa)
Plain brick	$0.25 f'_m$	$0.32 f'_m$	250
Reinf. brick	$0.25 f'_m$	$0.40 f'_m$	—
Plain concrete	$0.25 f'_m$	$0.30 f'_m$	hollow 160
			solid 250
Reinf. concrete	$0.25 f'_m$	$0.33 f'_m$	—

member at lateral supports (Fig. 4-b).

The ratio e_1/e_2 is positive when the member is bent in single curvature and negative for double curvature. When e_1 and or e_2 are equal to zero e_1/e_2 is assumed to be zero.

For each wall panel and for each case of loading the allowable load must be greater or equal to the actual applied load. Another way of checking safety is to calculate f'_m assuming that the actual load is the allowable one. Then the calculated f'_m (the required) should be less than the available f'_m of construction.

In the calculations of stresses the following notes should be considered :

1. For plain masonry and when $e/t < 1/3$ and where the virtual eccentricity in members produces cracking in the cross section, assuming that the masonry does not resist tension, then the stresses f_a and f_b shall be based on the reduced area of the cracked section (Fig. 5-a).

2. For plain masonry and when $e/t > 1/3$ the stress shall be calculated as follows :

a) The maximum compressive stress shall be calculated using the specified gravity load divided by the slenderness coefficient, C_s ; and

b) The maximum tensile stress shall be calculated with the axial component of the gravity load reduced to 80% of its specified value.

Walls subjected to bending about both axis (*i.e.*, M_x and M_y) have a similar procedure which is described in the code^[7].

4. Computer Program DESW

Based on the adopted code procedures, a computer program has been developed by the author. The program calculates first the loads and bending moments (M_y) for the desired panel for the five load combinations mentioned above and then returns the required compressive strength f'_m for each case. The available f'_m should be greater than the maximum required one otherwise the wall section has to be changed. The program follows up the steps of the flow chart of Fig. 3. Some common wall sections that can be analyzed by the program are shown in Fig. (5-b).

5. Behavior of Walls

Masonry walls can carry substantial axial loads but they can only carry small out-of-plane bending moment. In order to study the behavior of masonry walls under vertical and lateral loads, exterior walls of two and ten storey buildings (Fig. 6) are considered for parametric study. The study includes the effect of slab type, percentage of voids, area of mortar, area of grout, wall thickness, and percentage of reinforcement on f'_m . The dimensions and the loads are assumed, from practical applications, as follows :

- Floor dead load (hollow block slab) = 6 kN/m².
- Floor dead load (hollow core slab) = 4 kN/m².
- Roof dead load (hollow block slab) = 5 kN/m².

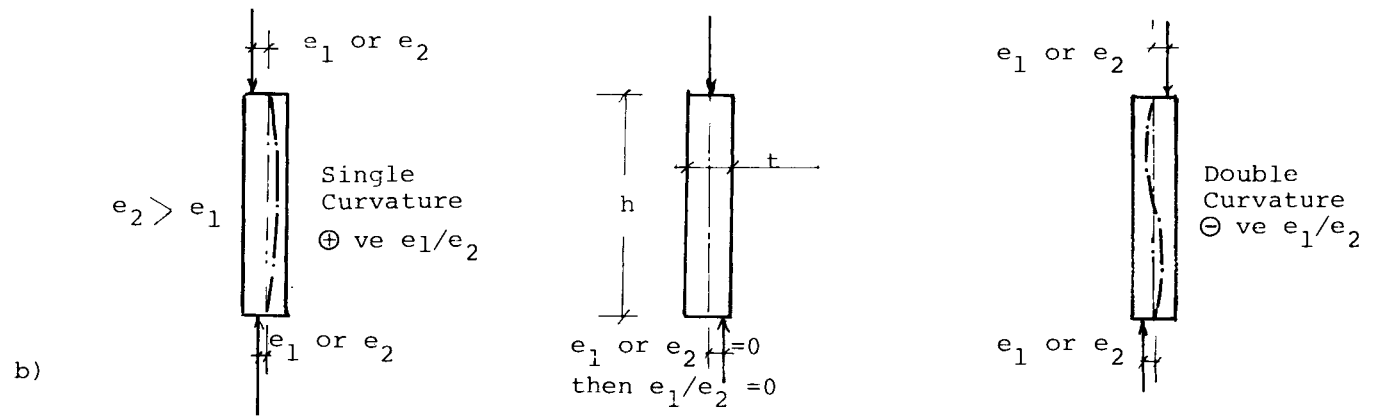
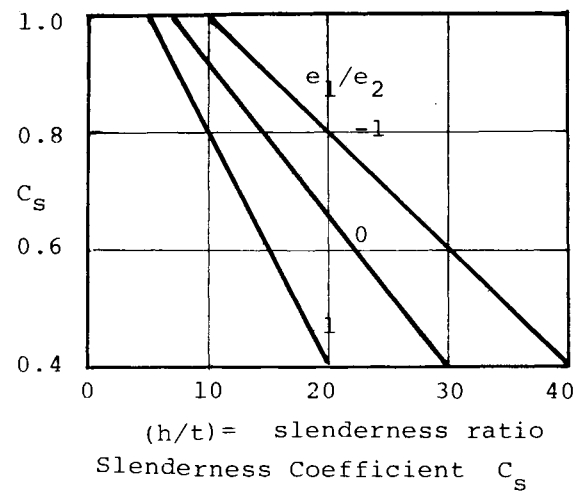
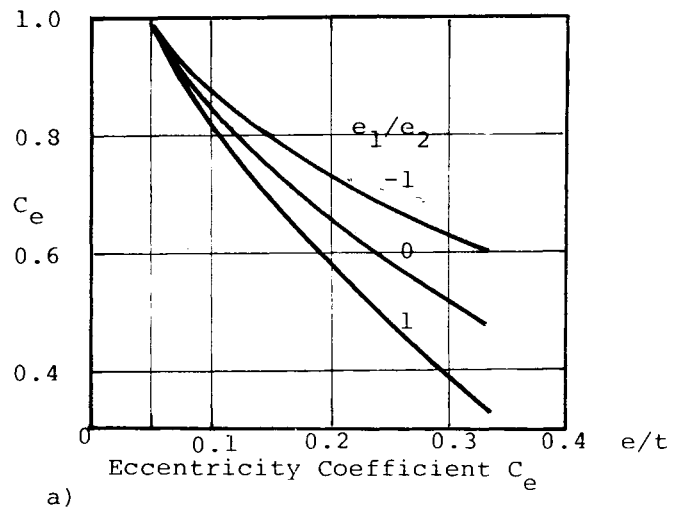

FIG. 4. Eccentricity and slenderness coefficients.

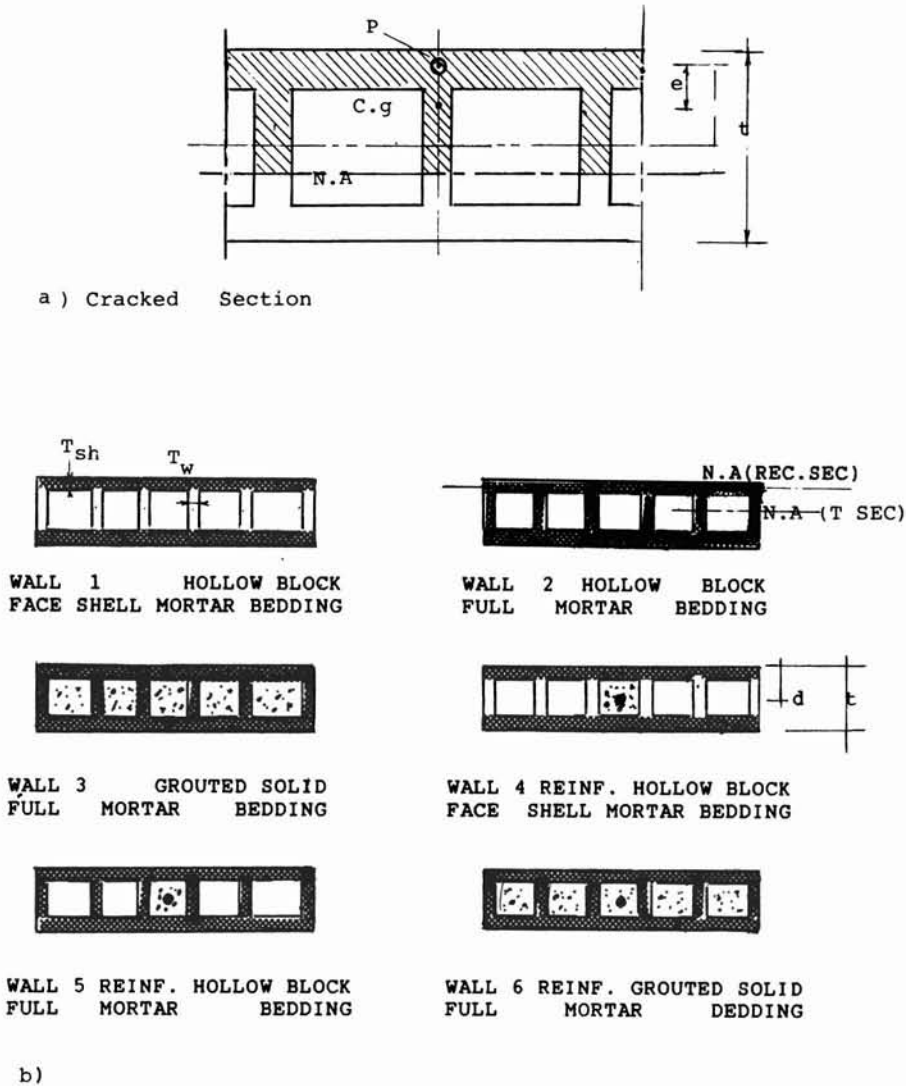

FIG. 5. Types of wall sections.

- Roof dead load (hollow core slab) = 3 kN/m^2 .
- Floor live load = 2 kN/m^2 .
- Roof live load = 1.5 kN/m^2 .
- Wind pressure = 1 kN/m^2 .
- M_x , for each panel, is calculated separately and fed as input data.
- Span of the one way ribbed slab = 5.0 m.

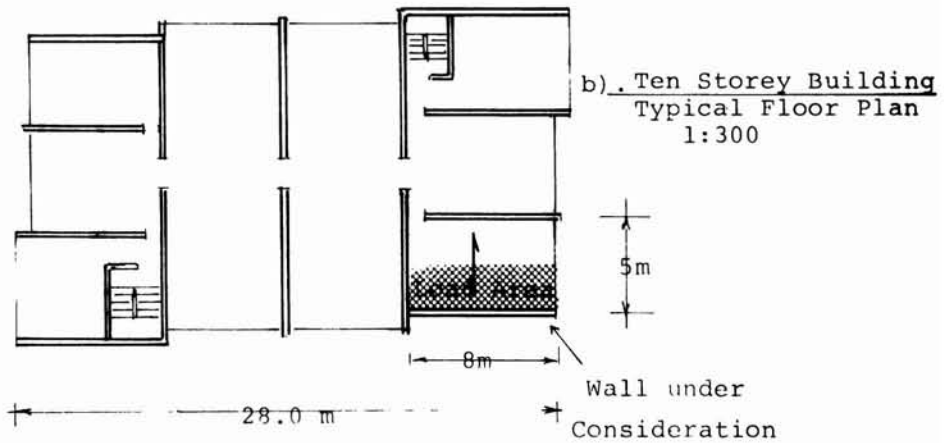
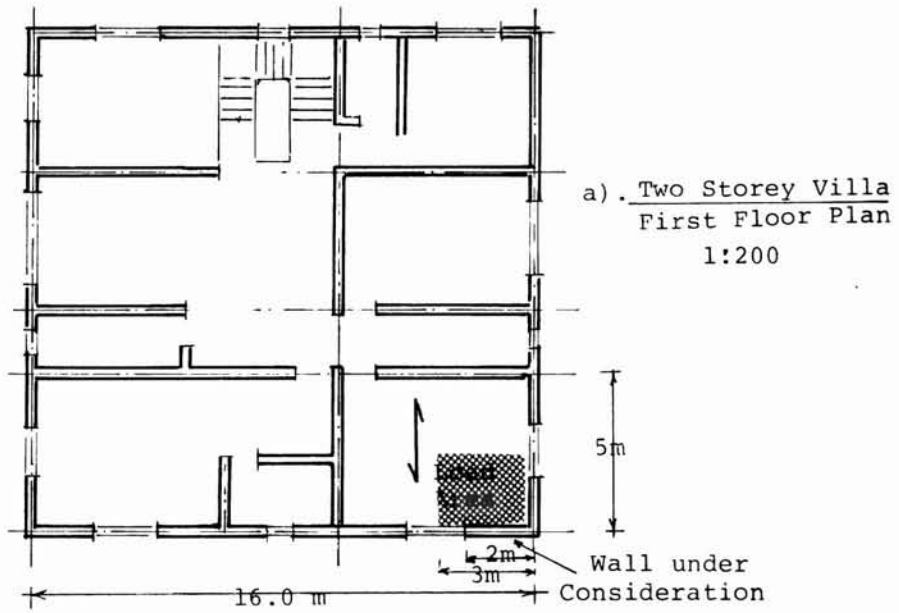

FIG. 6. Plans of two and ten storey buildings used as examples.

- Thickness of face shell $T_{sh} = 0.04$ m.
- Thickness of web $T_w = 0.05$ m (see Fig. 5-b).
- Ratio $d / t = 0.5$
- Steel ratio = area of steel/gross area of masonry = 0.2%.
- The rest of data are shown in Fig. 6.
- Experimental data presented in reference [6] shows that local production can have prism compressive strength higher than 12 MPa. Therefore a value of 12 MPa is considered as the available f'_m .

The six types of wall sections shown in Fig. 5-b are analyzed. The results are presented in Fig. 7, 8 and Table 2 in which the value of maximum f'_m , from the five cases of load combinations, are plotted against wall thicknesses.

TABLE 2. First safe wall section for hollow core slab buildings (f'_m in MPa).

Wall section	Two storey panels			Ten storey panels		
	t (cm)	1	2	t (cm)	1	10
		f'_m	f'_m		f'_m	f'_m
1	35	3.9	2.1	27.5	9.9	1.7
2	35	2.9	1.7	30.0	7.2	1.3
3	25	3.6	1.8	25.0	6.3	1.2
4	20	8.6	7.4	20.0	9.9	4.8
5	20	8.5	7.2	20.0	8.5	4.7
6	20	8.1	6.5	20.0	6.4	4.2

In the absence of significant axial compressive force the design of plain masonry is governed by the allowable tensile stresses (Table 1) which makes the walls of the upper floors require more thicknesses than the lower ones. This can be seen from Fig. 7 of the two storey villa with hollow block slabs. For example, while the wall section 1 with 25 cm is safe for the first wall (ground) the upper wall requires 30 cm to be safe. Under lighter dead loads from hollow core slabs this upper wall requires 35 cm (Table 2) which greatly reduces the required f'_m . On the other hand, design of reinforced masonry is usually governed by the available f'_m since the amount of reinforcement can be chosen according to the induced bending moment.

From Fig. 7, 8 and Table 2 the following conclusions, for low and medium-rise buildings, can be drawn.

5.1. Maximum f'_m

All maximum f'_m are less than 9 MPa for the two storey villa and 12 MPa for the ten storey building (except wall section 1 with thickness less than 30 cm, which is not practical for ten storey buildings). That makes most of the available local products suitable for masonry construction and supports the implementation plan suggested

in references [6, 10] for the use of loadbearing masonry in residential buildings in the Kingdom of Saudi Arabia.

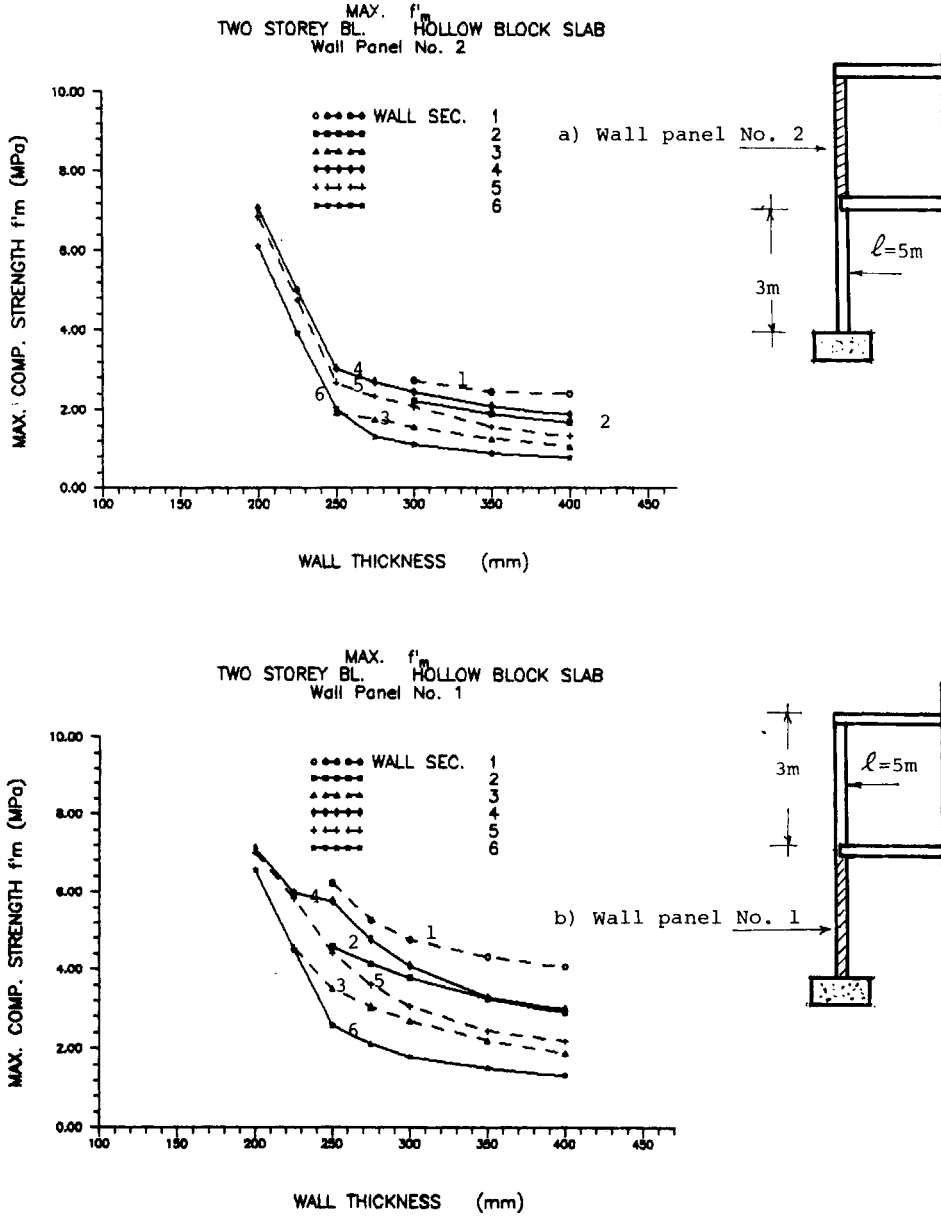

FIG. 7. Maximum required compressive strength f'_m versus wall thickness (two storey villa).

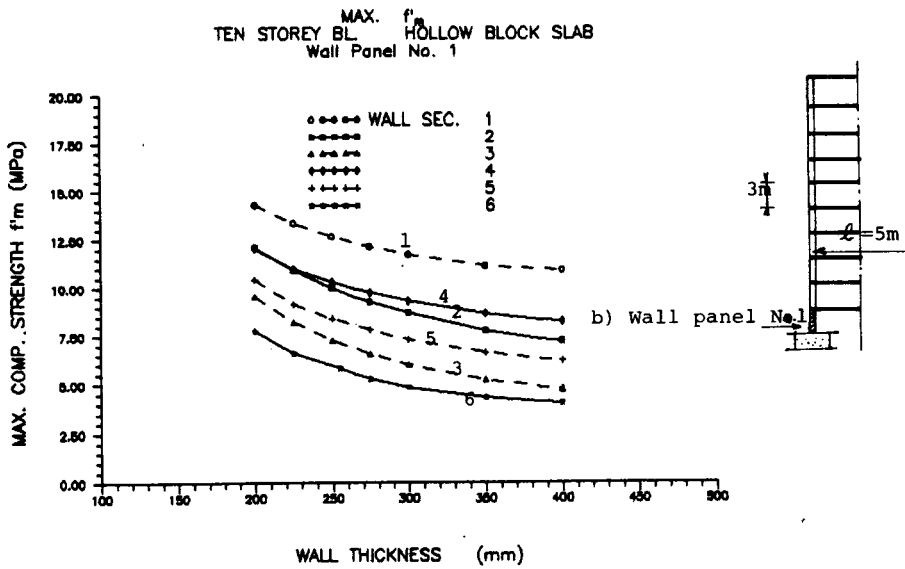
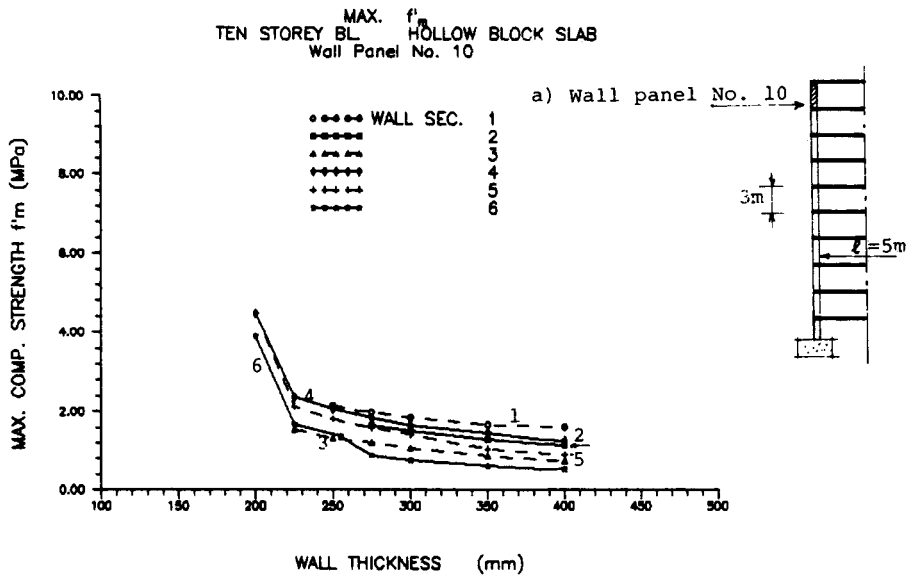

FIG. 8. Maximum required compressive strength f'_m versus wall thickness (ten storey building).

5.2. Minimum Thickness of Unreinforced Masonry

Two Storey Villa

Minimum thickness is 30 cm (35 cm^{*}) for hollow masonry (wall sections 1, 2) and 25 cm for solid masonry (wall section 3).

Ten Storey Building

Minimum thickness is 27.5 cm for hollow masonry (wall sections 1 of Fig. 8-b assuming f'_m maximum of 12 MPa), 27.5 cm (30 cm^{*}) for wall section 2, and 22.5 cm (25 cm^{*}) for solid masonry (wall section 3).

5.3 Minimum Thickness of Reinforced Masonry

Two and Ten Storey Buildings

Twenty centimeter wall thickness is safe for wall sections 4, 5, and 6. Therefore wall section 4, in which mortar covers only the face shell while the grouted cell and steel bars are placed 1 meter apart is recommended because it is the most practical and at the same time is more economical than the other two sections.

5.4. In General

Comparing reinforced and unreinforced masonry sections, the reinforced wall with 20 cm (section 4) is preferable than the unreinforced 30 or 35 cm walls. This is because reinforcement increases the ductility of the wall and hence its resistance to cracking.

6. Conclusion

Loadbearing masonry is a feasible cost-efficient building system for the Kingdom of Saudi Arabia. Its advantages, analysis, design, and behavior are discussed in this paper. The Canadian code, which is based on the working stress method, has been suggested to be adopted in the Kingdom until its own code is developed after an adequate data base becomes available. Based on this code parametric studies, using a specially developed computer program, are presented in the paper to facilitate the design of loadbearing walls.

Acknowledgements

The study was supported by a research grant from King Abdulaziz City for Science and Technology (KACST), which is greatly acknowledged.

List of Symbols

A_m	Mortar bedded area; that is net cross-sectional area at mortar joint.
C_e	Eccentricity coefficient.
C_s	Slenderness coefficient.

*Numbers in brackets are for hollow core slab.

d	Effective depth of wall section.
e	Virtual eccentricity.
e_1	The smaller virtual eccentricity at the top or bottom of a vertical member at lateral support.
e_2	The larger virtual eccentricity at the top or bottom of a vertical member at lateral support.
f'_m	Ultimate compressive strength of masonry at 28 days.
$f_{a,b}$	The calculated axial compressive and flexural compressive stresses respectively.
$F_{a,b,t}$	The tabulated allowable axial compressive, flexural compressive, and flexural tensile stresses respectively.
h	Effective height of a wall.
M	Bending moment.
P	Axial load in wall, allowable vertical load.
t	Effective thickness of wall.
T_{sh}	Thickness of face shell.
T_w	Thickness of web.

References

- [1] **Fereig, S. and Horn, M.**, Introduction of reinforced masonry system to Kuwait building industry, *Third North American Masonry Conference, Univ. of Texas at Arlington* (1985).
- [2] **Hamid, A.**, The use of loadbearing block masonry in residential building construction in Egypt, Presented in: *The Conference on Safety of Structures, Ain Shams University, Cairo, April* (1988).
- [3] **Hamid, A.**, Loadbearing masonry construction, *Proceedings of a 4-day Seminar on: Cost-Efficient Building Systems and Their Adaptability to Residential Building Construction in Egypt, Ain Shams University, Cairo, Jan.* (1985).
- [4] **Hamid, A., Harris, H., Drysdale, R. and Suter, G.**, Engineering Masonry, *Lecture Notes for a 2-Day Practice-Oriented Course, Philadelphia, Penn., Oct.* (1982).
- [5] **Hart, G. and Englekirk, R.**, *Earthquake Design of Concrete Masonry Buildings*, Prentice-Hall Inc., Englewood Cliffs, New Jersey (1982).
- [6] **Meddallah, K., Aboul-Ella, F. and Numan, M.**, A Study of one of the Building Systems Currently in Extensive use in Saudi Arabia, *Research Project AR 1/24 Conducted at King Faisal University, College of Arch., Dammam and Funded by King Abdulaziz City for Science and Tech., Riyadh, Saudi Arabia, Final Report, Rabi I* (1410 A.H.).
- [7] **National Research Council of Canada (NRC)**, Masonry Design for Buildings, *CAN3-S304-M84*, Nov. (1984).
- [8] **American Concrete Institute (ACI)** Standard 531-83. *Building Code Requirements for Concrete Masonry Structures*, Detroit, Michigan (1979).
- [9] **Hendry, A.W.**, Wall/Floor-Slab Interaction in Brickwork Structures, *New Analysis Techniques for Structural Masonry, Proceedings of a Session Held in Conjunction with Structures Congress '85, Chicago, Illinois, Sept.* (1985).
- [10] **Medallah, Kh., Aboul-Ella, F. and Hamid, A.**, The use of loadbearing masonry in residential building construction in Saudi Arabia, *The Fifth Canadian Masonry Symposium, Vancouver, B.C., June* (1989).

سلوك حوائط البلوكات الحاملة

فخري أحمد أبو العلا

قسم علوم وتقنية البناء ، كلية العمارة والتخطيط ، جامعة الملك فيصل
الدمام - المملكة العربية السعودية

المستخلص . تعتبر حوائط البلوكات الحاملة أعضاء نحيفة معرضة للضغط والانحناء . وقد تمت دراسة سلوك هذا النوع من الحوائط باستخدام برنامج حاسب آلي (DESW) يحلل ويصمم تلك الحوائط ، مما يسهل عمل دراسات مقارنة لها . الدراسة المقدمة تشمل تأثير كل من سمك الحائط ، نوع البلاطة ، نسبة الفراغات ، المساحة المعرضة للملاط ، مساحة خرسانة الحقن ، نوع البلوكات ، وكذلك نسبة الفولاذ الرأسي على سلوك الحائط . وقد خلص البحث إلى أن قطاع الحائط المفرغ ، الذي توضع فيه قضبان الفولاذ وخرسانة الحقن على بعد متر واحد ، مع وضع الملاط على حواف القطاع الجانبية ، هو أفضل نظام للمباني القليلة والمتوسطة الارتفاع في المملكة العربية السعودية .